

► SPECIFICATIONS

Alldrive 6 Tonne Powerswivel

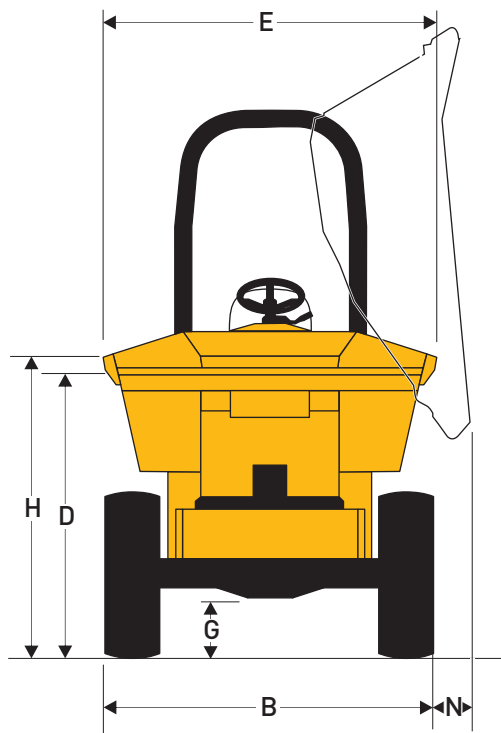
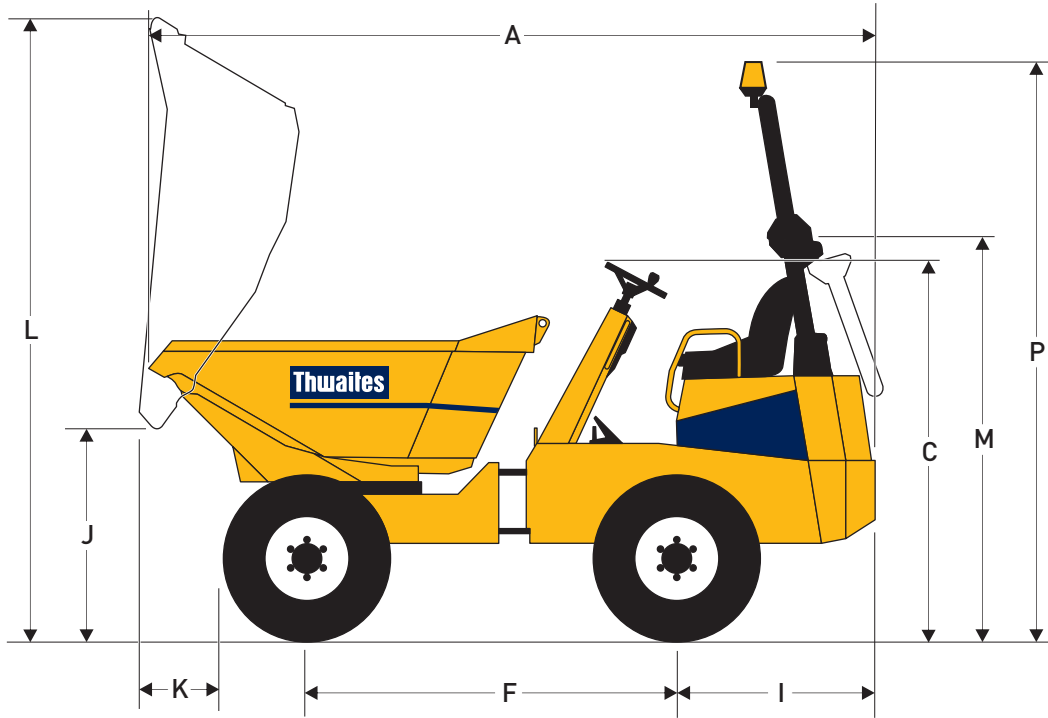

**Dimensions
(mm)**

A	4780
B	2280
C	2230
D	1670
E	2240
F	2480
G	370
H	1850
I	1200
J	1100
K	550
L	3694
M	2230
N	100
P	3300

SPECIFICATIONS

Alldrive 6 Tonne Powerswivel

Capacities	Max. safe load	6000 kg
	Heaped	3150 litres
	Struck	2550 litres
	Water	1650 litres

Engine

Perkins 1100 D series, 70kW/94 bhp (gross) at 2200 rpm, four-cylinder turbo-charged water-cooled direct injection diesel. Max. torque 392 Nm (289 lb ft). Hour meter, battery isolation switch and heavy-duty cyclonic air cleaner positioned within the lockable engine compartment. Tier 3-/Stage IIIA-compliant.

Noise Levels

Operator's ear 84 LpA, airborne sound power level 102 LwA (to 2000/14/EC).

Transmission

Torque converter four-speed forward and reverse powershuttle transmission with column-mounted directional control lever. Heavy-duty gear driven transfer box. Optional 'Powershift' transmission with changes of speed and forward/reverse direction controlled by one column-mounted lever.

Speeds	Forward and Reverse	
	1	5.0 km/h (3.1 mph)
	2	8.0 km/h (5.0 mph)
	3	15.1 km/h (9.3 mph)
	4	27.7 km/h (17.2 mph)

Tyres	405/70 x 20
	14 ply
	Track grip tread

Brakes and Axles

Twin-circuit totally enclosed multiplate oil-immersed discs mounted on both axles with automatic adjustment for wear. Hand-operated parking brake. Heavy-duty axles with epicyclic reduction and fully floating halfshafts.

Kinglink Chassis

Front and rear chassis constructed from deep section folded steel plate, with three-point Kinglink giving centre articulation and oscillation for better stability, traction and extra safety on site. Remote greasing point provided for lubrication of top Kinglink articulation pin.

Skip

Hydraulically operated, 8 mm steel base plate, fully welded, mouth and sides of skip reinforced with box sections giving greater strength to minimise skip damage. No material traps. Powerswivel mounted on ball bearing turntable with powered rotation through 180° by means of twin slewing cylinders, operated by a single dual-axis control lever. Automatic safety lock holds skip in central position when travelling.

Seating & Controls

Adjustable suspension seat, accessible from both sides. Audible warning device for handbrake in 'on' position. Electric horn. Large pedal pads with handbrake and hydraulic controls ready to hand. Super-bright warning lights for all critical functions.

Service Access

Lockable three-sided cover opens to provide easy access from ground level to engine service points, all located on the same side. Rear chassis panel can be hinged back on retainers. Additional service access door incorporates the battery. Moulded diesel and hydraulic tanks positioned low in the chassis side members, permitting access to the filler caps from ground level.

Electrics

Wiring harness contained within conduits and all electrical components water resistant to IP65/67 standards.

Steering & Hydraulics

Hydraulic priority power steering. Filter mounted on the top of the tank accessible from ground level. Hydraulic test point fitted as standard.

Tank Capacities	Fuel	70 litres
	Hydraulic	70 litres

Shipping Cube	24.2 m ³ (without ROPS)
----------------------	------------------------------------

Unladen Weight	4275 kg (Powershuttle)
	4340 kg (Powershift)

Clearance Diameter	12 m
---------------------------	------

Towing Bracket	Standard
-----------------------	----------

ROPS

For the UK and other markets where it is a legal requirement a fully approved folding ROPS frame is fitted as standard.

Optional Extras

ROPS/FOPS frame and canopy. Beacon. Full road lighting equipment. UK road equipment. Anti-theft device.

Thwaites

Thwaites Ltd. Leamington Spa, Warwickshire CV32 7NQ, England
Tel +44 (0)1926 422471 Fax +44 (0)1926 337155
www.thwaitesdumpers.co.uk

Distributor



We reserve the right to change all specifications without prior notice.
Printed in England 03/2008